











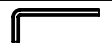

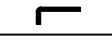
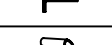





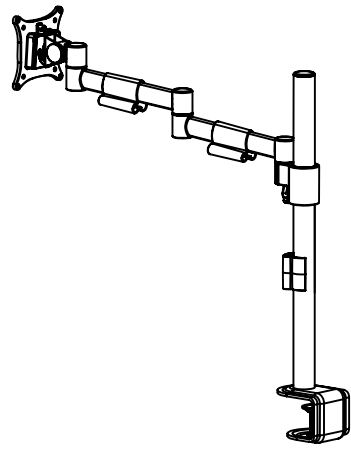



Installation Manual









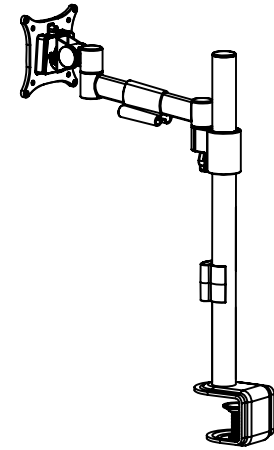

Parts list

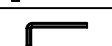
No.	ITEM	SPECS	QUANTITY
A			4
B			4
C		M6	1
D		M4	1
E		M3	1
F		M2.5	1
G			1
H			1
I			1
J		M8*90	1
K			1



No.	ITEM	SPECS	QUANTITY
A			4
B			4
C		M6	1
D		M4	1
E		M3	1
F		M2.5	1
G			1
H			1
I			1
J		M8*90	1
K			1





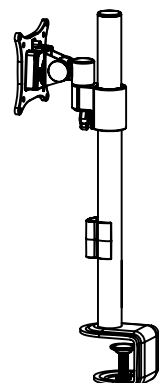





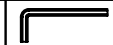

No.	ITEM	SPECS	QUANTITY
A			4
B			4
C		M6	1
D		M4	1
E		M3	1
F		M2.5	1
G			1
H			1
I			1
J		M8*90	1
K			1

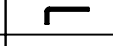
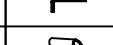







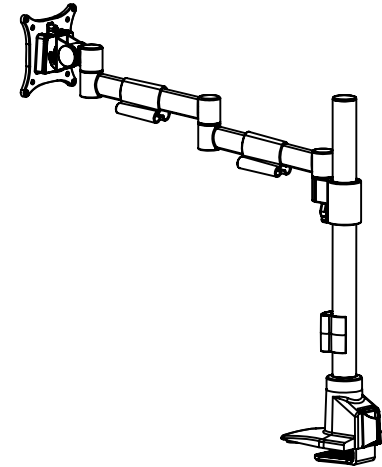



Installation Manual

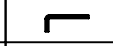
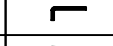







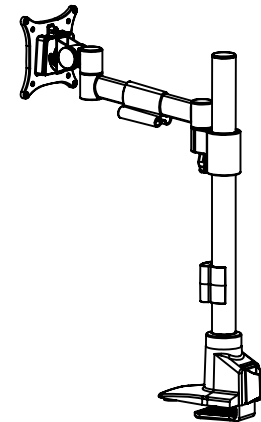

Parts list

No.	ITEM	SPECS	QUANTITY
A			4
B			4
C		M6	1
D		M4	1
E		M3	1
F		M2.5	1
G			1
H			1
I			1
L		set screws M6*6	1
M			1
N		M8*160	1

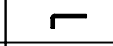

No.	ITEM	SPECS	QUANTITY
A			4
B			4
C		M6	1
D		M4	1
E		M3	1
F		M2.5	1
G			1
H			1
I			1
L		set screws M6*6	1
M			1
N		M8*160	1





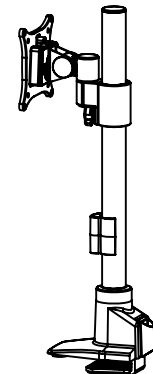







No.	ITEM	SPECS	QUANTITY
A			4
B			4
C		M6	1
D		M4	1
E		M3	1
F		M2.5	1
G			1
H			1
I			1
L		set screws M6*6	1
M			1
N		M8*160	1

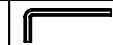

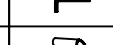







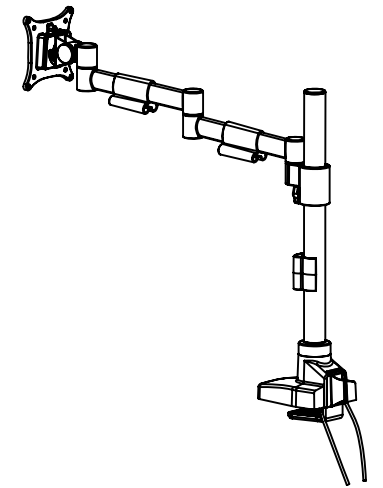



Installation Manual

Parts list









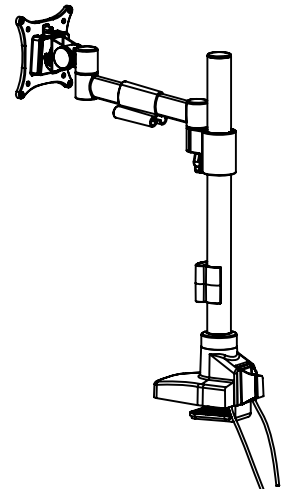



www.filex.nl

No.	ITEM	SPECS	QUANTITY
A			4
B			4
C		M6	1
D		M4	1
E		M3	1
F		M2.5	1
G			1
H			1
I			1
L		set screws M6*6	1
M			1
N		M8*160	1



No.	ITEM	SPECS	QUANTITY
A			4
B			4
C		M6	1
D		M4	1
E		M3	1
F		M2.5	1
G			1
H			1
I			1
L		set screws M6*6	1
M			1
N		M8*160	1



No.	ITEM	SPECS	QUANTITY
A			4
B			4
C			1
D		M4	1
E		M3	1
F		M2.5	1
G			1
H			1
I			1
L		set screws M6*6	1
M			1
N		M8*160	1

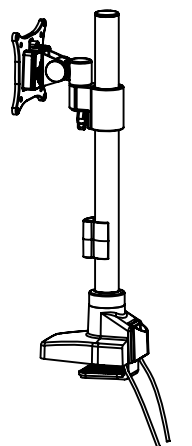

Installation Manual

Clamp Installation

I Desk Clamp

Clamp range: 15mm-50mm

I Thru-Desk

hole: $\geq 8.5\text{mm}$

Desk thickness: 10mm-50mm

II Desk Clamp

Clamp range: 15mm-50mm

II Thru-Desk

hole: $\geq 8.5\text{mm}$

Desk thickness: 10mm-50mm

III Desk Clamp

Clamp range: 15mm-50mm

III Thru-Desk

hole: $\geq 8.5\text{mm}$

Desk thickness: 10mm-50mm

Installation Manual

Arm Installation

Installation Manual

Arm Adjustment