



















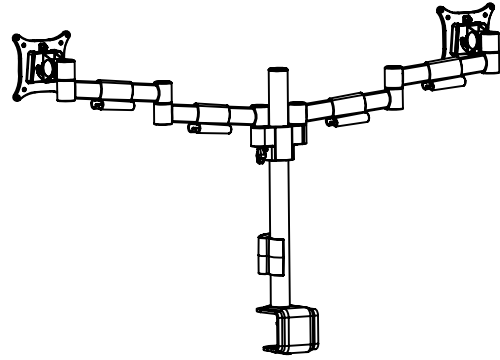



Installation Manual









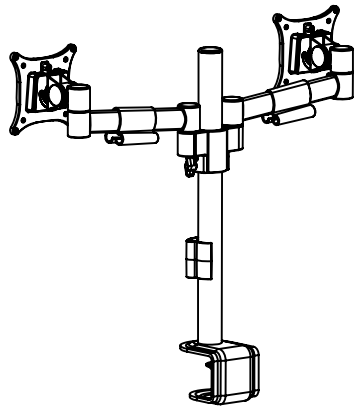

Parts list

No.	ITEM	SPECS	QUANTITY
A			8
B			8
C		M6	1
D		M4	1
E		M3	1
F		M2.5	1
G			1
H			2
I			1
J		M8*90	1
K			1



No.	ITEM	SPECS	QUANTITY
A			8
B			8
C		M6	1
D		M4	1
E		M3	1
F		M2.5	1
G			1
H			2
I			1
J		M8*90	1
K			1





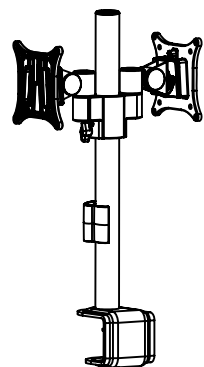









No.	ITEM	SPECS	QUANTITY
A			8
B			8
C		M6	1
D		M4	1
E		M3	1
F		M2.5	1
G			1
H			2
I			1
J		M8*90	1
K			1









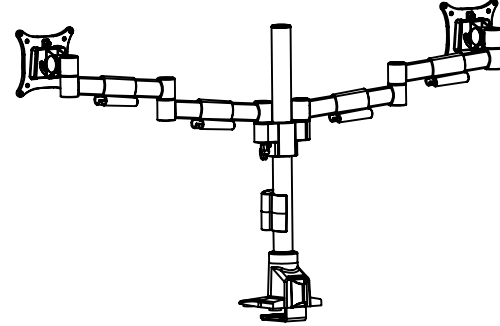





Installation Manual









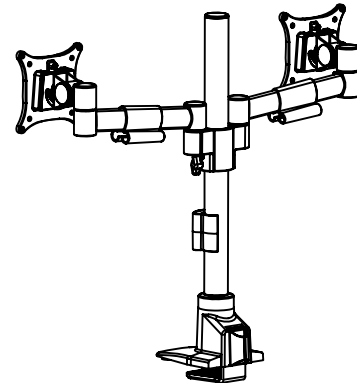



Parts list

No.	ITEM	SPECS	QUANTITY
A			8
B			8
C		M6	1
D		M4	1
E		M3	1
F		M2.5	1
G			1
H			2
I			1
L		set screws M6*6	1
M			1
N		M8*160	1



No.	ITEM	SPECS	QUANTITY
A			8
B			8
C		M6	1
D		M4	1
E		M3	1
F		M2.5	1
G			1
H			2
I			1
L		set screws M6*6	1
M			1
N		M8*160	1





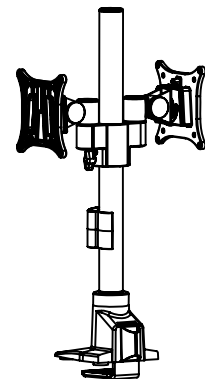









No.	ITEM	SPECS	QUANTITY
A			8
B			8
C		M6	1
D		M4	1
E		M3	1
F		M2.5	1
G			1
H			2
I			1
L		set screws M6*6	1
M			1
N		M8*160	1









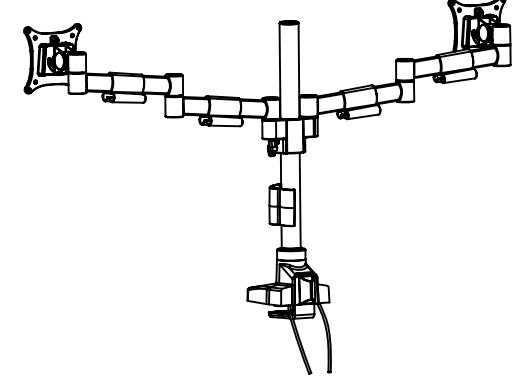





Installation Manual









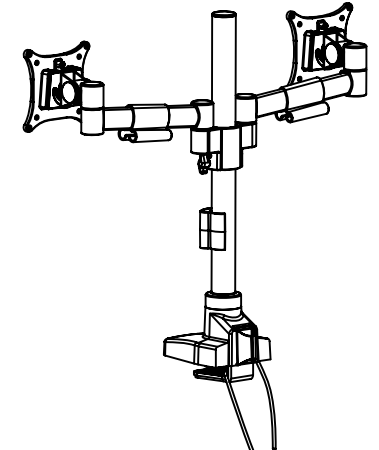



Parts list

No.	ITEM	SPECS	QUANTITY
A			8
B			8
C		M6	1
D		M4	1
E		M3	1
F		M2.5	1
G			1
H			2
I			1
L		set screws M6*6	1
M			1
N		M8*160	1



No.	ITEM	SPECS	QUANTITY
A			8
B			8
C		M6	1
D		M4	1
E		M3	1
F		M2.5	1
G			1
H			2
I			1
L		set screws M6*6	1
M			1
N		M8*160	1



No.	ITEM	SPECS	QUANTITY
A			8
B			8
C		M6	1
D		M4	1
E		M3	1
F		M2.5	1
G			1
H			2
I			1
L		set screws M6*6	1
M			1
N		M8*160	1

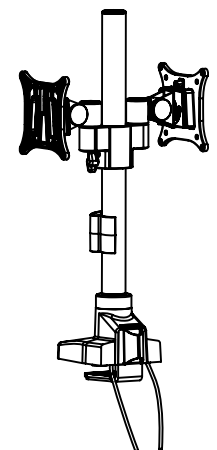

Installation Manual

Clamp Installation

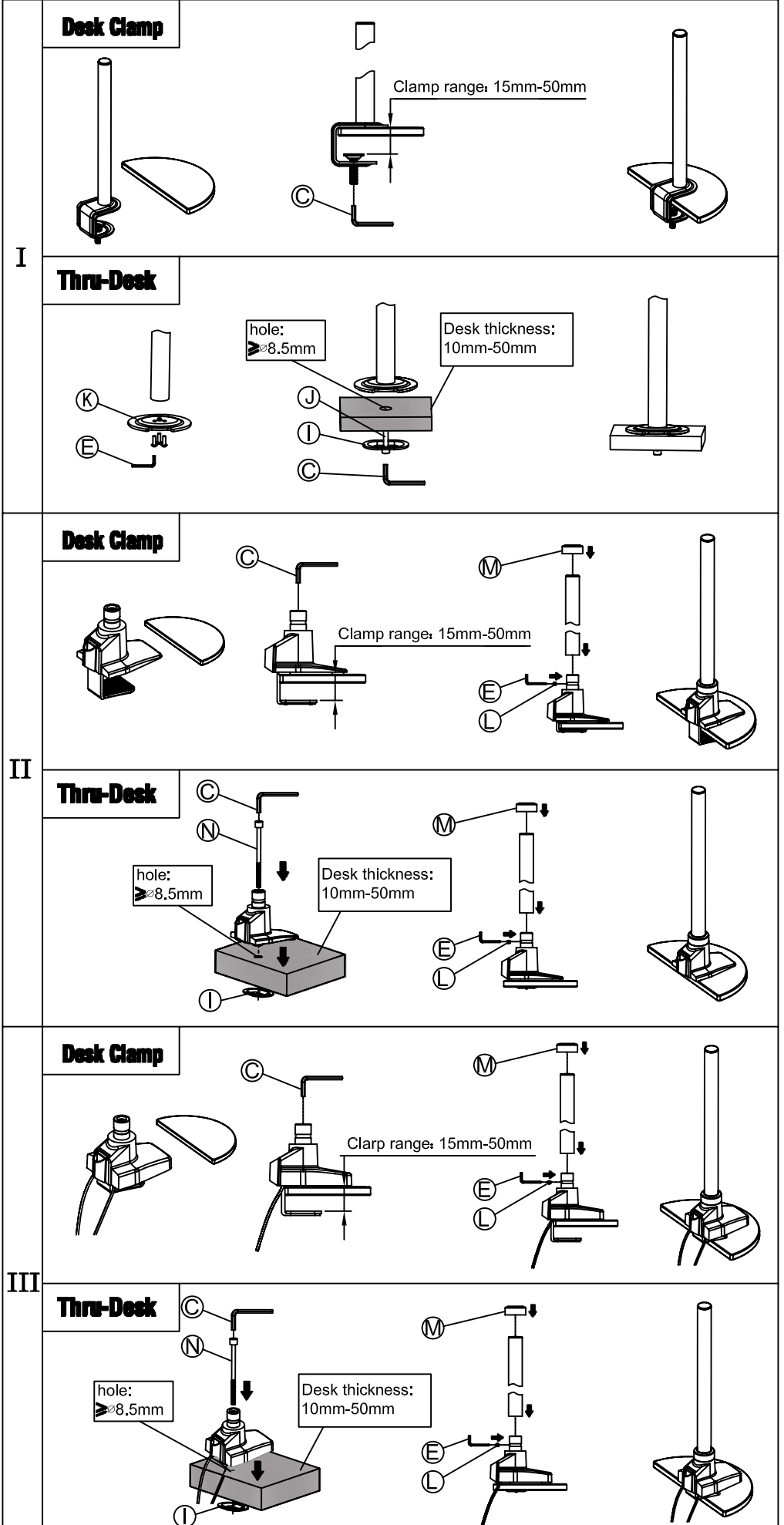

Installation Manual

Arm Installation

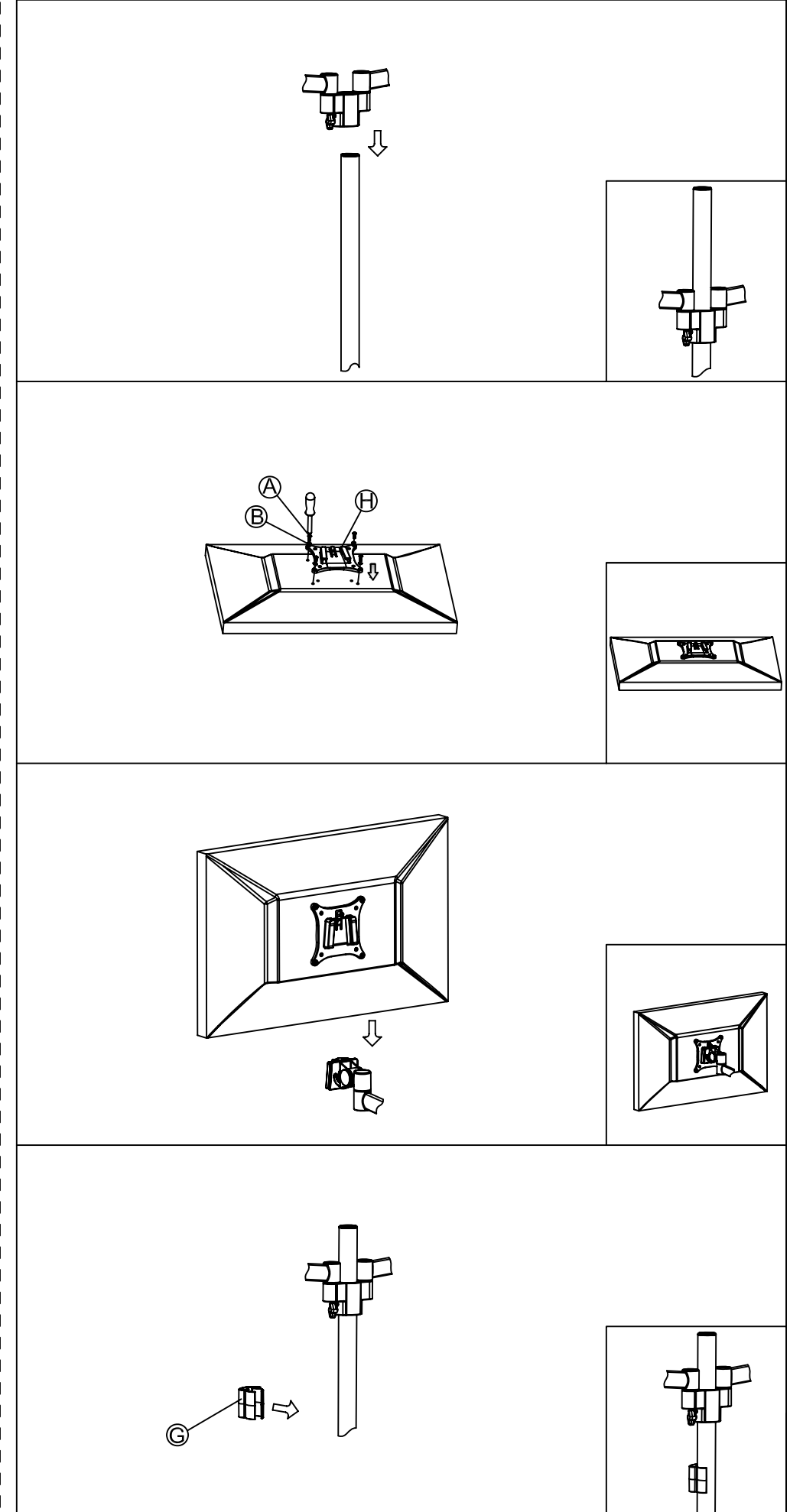

Installation Manual

Arm Adjustment

